

The ultimate

Yours to choose



Perfection in your hands



Designed for the highest success.

Unique Alpine has been known as one of the leading specialists in military and police precision rifles for decades. Based on this expertise and the aspiration to develop ourselves and our products, we transferred our knowledge to the areas of hunting and sport.

We now offer these newly developed rifle systems onto the market – and would therefore like to work with you, either as a trading partner or even potentially as a top trading partner (ProShop) with exclusive advantages, closely tied to our brand. Discover on the following pages what makes us and our products so fascinating and unique – and see for yourself why our rifle series should be an integral part of your retail product range.



Stefan Holme, CEO

Precision Tools - Made in Bavaria.

At Unique Alpine, located in the Bavarian town of Erding, decades of tradition and history are rooted in forward thinking, vision and the highest standards of true passion.

Our goal is always to develop, build and deliver the best product .

With our new „state of the art“ product – series TPG, UPG and JPR – we now offer rifles that are the result of these high standards.

Sophisticated in every detail and equipped with enviable pioneering technologies, these rifles combine surgical precision with absolute reliability – each technology an indispensable feature for success whether hunting, or target shooting.

Our rifles include as much as possible in their design. Every wish a shooter can make of his rifle is included – in a price class that is incredibly competitive and within reach of all shooters, beginner or full-blooded pro.



Perfection in your hands

A close-up, low-angle shot of a tan-colored sniper rifle with a scope and a cap resting on a dark gravel surface. The rifle is the central focus, with its barrel pointing towards the right. In the background, a lush green field stretches out, leading to a dense forest of tall, thin trees. The lighting is soft, suggesting an overcast day. The overall mood is quiet and focused.

Sporting success
is always a matter
of passion.

Passion meets perfection at Unique Alpine

TPG-3 A4

The tactical powerhouse.



Our multi caliber capable flagship product. Designed and built for professional users and to comply with the NATO AC/225 D14 specification. The TPG-3 leaves nothing to be desired in range, precision, modularity, robustness and workmanship.



Features TPG-3 A4



BUTTSTOCK

The buttstock is collapsible to the right without changing the overall width of the gun. Simultaneously, the bolt handle is secured. Overall length, cheek piece, and butt plate height angle and height are fully adjustable. A picatinny-interface allows for the use of a monopod or spacer plate from our range of accessories.



BARREL CHANGE

The barrels can be changed in less than one minute without any special tools or other devices and fixed repeatability in the system by means of four loss-protected integrated clamping screws.



RAILS

Freely positionable Picatinny mounting rails (MilSpec 1913 Rail) are available in five different lengths and can be mounted and form-fitted to eight different angles around the hand guard.



MATCH GRADE TRIGGER

The match grade trigger can be precisely adjusted to your wishes. It has an outstanding, crisp characteristic for optimal trigger control.



MAGAZINE

The magazines are made out of fiber-glass-reinforced, high-performance plastic. They are available in all three calibers and come in a short and long versions. The high-strength plastic is far superior to metal as a material for magazines since the material does not bend or deform under stress like a traditional steel magazine; therefore, feeding faults belong to the past.



SAFETY CONCEPT

- a) Firing Pin Safety
- b) Safety catch in case of an internal safety failure
- c) Grip safety (optional)

Technical specifications

MAGAZINE:	Polymer double stack .338 Lap. Mag./300 Norma Mag.: 8/5 rounds .300 Win. Mag.: 10/6 rounds .308 Win./6,5 Creedmoor: 10/15 rounds
BARREL:	Heavy matchbarrel equipped with muzzlebrake featuring the X2 suppressor interface
CALIBER:	.338 Lapua Mag., .300 Norma Mag., .300 Win. Mag., .308 Win 6,5 Creedmoor
TRIGGER:	Double stage, adjustable, 1,5- 2,5 kg
BARREL LENGTH:	.338 LM: 26" (660 MM) .300 NM: 26" (660 mm) .300 Win. Mag.: 26" (660 mm) .308 Win.: 16,5" (419 mm) • 24" (609 mm) • 26" (660 mm) 6,5 Creedmoor: 26" (660 mm)
SCOPE INTERFACE:	20 MOA, STANAG 4694 (Picatinny, compatible with Mil. Spec. 1913)
OVER ALL LENGTH:	91 cm - 125 cm
WEIGHT:	Approx. 6,2 kg depending on Barrel length

Accessories TPG-3 A4



TPG-3 Caliber Conversion Kit



TPG-3 Barrel



X-Connect Rails



TPG-3 magazines



Buttstock Grip Extension



X2 - Tactical Suppressor

TPG NX

The next step in the evolution.



Law Enforcement/Military only



The next step in the evolution of the tactical precision rifle. Developing the TPG-NX the goal was uncompromising modularity, ergonomics and utmost accuracy. We are confident to supply the most advanced multi caliber rifle on the market.

Features TPG-NX



True Primary Extraction



UA Muzzle Brake for QD Suppressor



Match Grade 2 Stage Trigger 0.9-2.5kg and Ambidextrous Magazine Release



Multi Caliber, Solid 3-Lug Bolt with 60° bolt throw



Ambidextrous 3 position striker safety



Full Length Top Rail, 20MOA



M-Lok Handguard



Detachable, Folding Stock. Continuously Adjustable LOP, 13"-15.5". Multiaxially Adjustable Cheek Rest and Recoil Pad. 3 QD Sling Attachment Points on the Stock. Compatible with Standard AR15 Pistol Grips.

RELEASE
THE BE(A)ST.



Features UPG



PRIMARY EXTRACTION

The extraction starts with the rotation of the bolt. Stuck cases are a thing of the past, easy removal and safe ejection of the case or cartridge is ensured under all conditions.



CONTROLLED FEEDING

The cartridge is pushed under the extractor claw and held there during feeding. As a result, a safe and trouble-free feeding of the cartridge into the chamber is achieved in every possible weapon position.



CONTROLLED EJECTION

The case is held in the ejection process by the extractor claw until it is ejected by the fixed ejector. Depending on the bolt velocity, the case drops or flies out of the action. This allows a situation-dependent ejection.



3-POSITION-SAFETY

The safety has three positions: „fire“, „safe“ and „safe + locked“. The safety acts directly on the striker therefore an accidental discharge as a result of a broken sear is impossible.

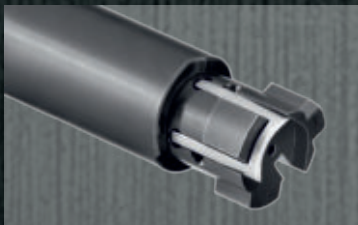

3-LUG-BOLT

Robust and reliable locking through three load bearing lugs machined from special high strength steel. The resulting 60° bolt throw allows for fast and reliable operation under all conditions.



MATCH GRADE TRIGGER

The match grade trigger can be precisely adjusted to your wishes. It has an outstanding, crisp characteristic for optimal trigger control.



MUZZLETHREAD

All rifles of the JPR and UPG series feature a threaded muzzle.



OPENING ANGLE

The small opening angle of 60° allows fast cycling.



STOCK

The stock of the UPG-1 is adjustable for LOP and comb height. Additionally the complete Stock assembly can be removed and e.g. be exchanged with a folding stock.

UPG-1 Fixed Stock

The universal all-rounder.



Developed in our tradition of striving for perfection. A chassis system that cuts no corners. With a wide range of supported calibers, barrel lengths and stock options the rifle can be configured to suit your individual application.

UPG-1 AR-15 Foldable Buttstock

The modular all-rounder.



- 6 Position Adjustable Stock
- Adjustable Cheek Rest
- Mil-Spec Buffer Tube



Barrel length 16.5"



UPG-1 UA Foldable Buttstock

The versed specialist.



- Continuously Adjustable LOP
- Adjustable Cheek Rest
- Ambidextrous QD Sling Attachment Points



Accessories UPG-1

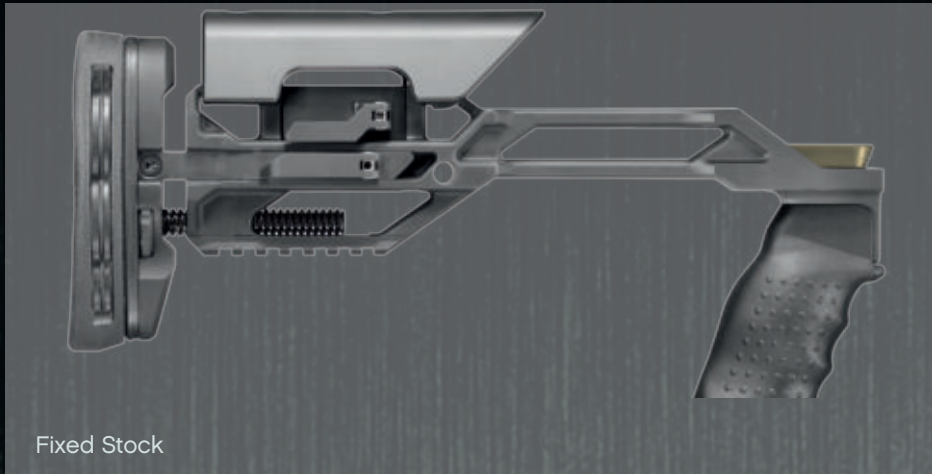

Fixed Stock

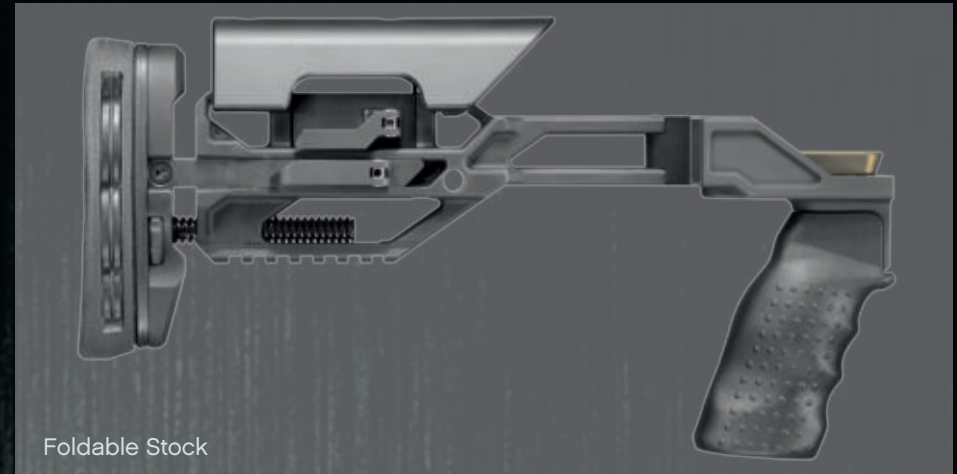

Foldable Stock



Foldable AR15 stock



We hunt to live.

JPR-1 Features

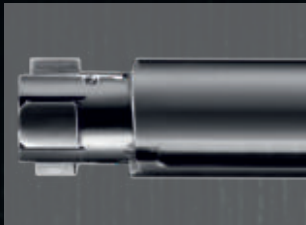

PRIMARY EXTRACTION

The extraction starts with the rotation of the bolt. Stuck cases are a thing of the past, easy removal and safe ejection of the case or cartridge is ensured under all conditions.

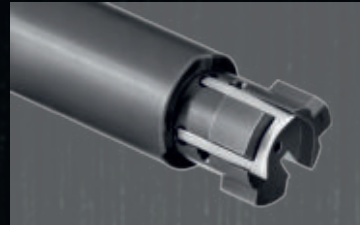

CONTROLLED FEEDING

The cartridge is pushed under the extractor claw and held there during feeding. As a result, a safe and trouble-free feeding of the cartridge into the chamber is achieved in every possible weapon position.



CONTROLLED EJECTION

The case is held in the ejection process by the extractor claw until it is ejected by the fixed ejector. Depending on the bolt velocity, the case drops or flies out of the action. This allows a situation-dependent ejection.

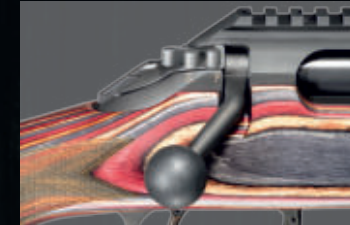

3-POSITION-SAFETY

The safety has three positions: „fire“, „safe“ and „safe + locked“. The safety acts directly on the striker therefore an accidental discharge as a result of a broken sear is impossible.



3-LUG-BOLT

Robust and reliable locking through three load bearing lugs machined from special high strength steel. The resulting 60° bolt throw allows for fast and reliable operation under all conditions.



MATCH GRADE TRIGGER

The match grade trigger can be precisely adjusted to your wishes. It has an outstanding, crisp characteristic for optimal trigger control.

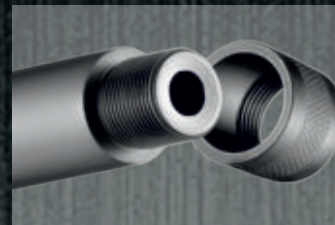

MUZZLETHREAD

All rifles of the JPR and UPG series feature a threaded muzzle.



OPENING ANGLE

The small opening angle of 60° allows fast cycling.



JPR-1 Europa

The timeless classic.



- Walnut Stock, Ebony Stock Tip and Pistol Grip Cap
- Ambidextrous Stock Design
- Sling Studs
- Muzzle Thread M15x1



The modern JPR action combined with a timeless, classic walnut stock.

Nonaco



- Exclusive Walnut Stock, Ebony Stock Tip and Pistol Grip Cap
- Ambidextrous Stock Design
- Sling Studs
- Muzzle Thread M15x1

Elegant, exclusive, perfect in form. The smooth lines reflect our interpretation of a century old tradition of craftsmanship. Modern materials combined with grade AA walnut stock compose the foundation for your hunting experience.





JPR-1 Kodiak

The sturdy companion.



- Robust, all weather Laminated Stock
- Ambidextrous Stock Design, Sling Studs
- Detachable Optics Rail
- Muzzle Thread 5/8"-24 UNEF



Classic shape meets modern style. The Kodiak displays your confidence while being rugged and reliable. Your trusty companion in the wild.

JPR-1 Kodiak Scout

The reliable adventurer.

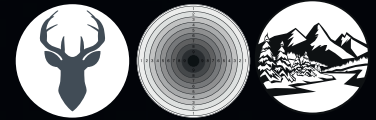

- Robust, all weather Laminated Stock
- Ambidextrous Stock Design
- Sling Studs
- Extended Optics Rail, Ghost Ring Sights
- Muzzle Thread 5/8"-24 UNEF

Our Kodiak Scout model is the universal partner for your great adventure. Compact, practical, versatile she fits on every backpack.



JPR-1 Nordland

The versatile professional.



- Length and Height Adjustable GRS Berserk Polymer Stock
- QD Sling Studs
- Integrated Picatinny Rail (STANAG 4694)
- Muzzle Thread 5/8"-24 UNEF



Ergonomic perfection meets robustness. Our Nordland covers any demands the modern hunter or competitive shooter has under any environmental condition.

JPR-1 Nordland Scout

The flexible multi-talent.

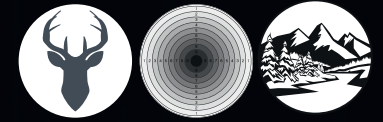

- Length and Height Adjustable GRS Berserk Polymer Stock
- QD Sling Studs
- Integrated Picatinny Rail (STANAG 4694)
- Rail Extension for NV
- Muzzle Thread 5/8"-24 UNEF

Our Nordland Scout with extended „workspace“. The extended Picatinny rail allows for mounting of thermal/night vision attachments. Be prepared for day and night.



JPR-1 Highland



The experience long range shooter.



Shaft color wood gray-blue

Shaft color natural wood

- Competition Style Ergonomic Laminated Stock, Ambidextrous Stock Design, available in Gray and Brown
- Integrated Picatinny Rail (STANAG 4694)
- Muzzle Thread 5/8"-24 UNEF



Our Highland model sports an elegant yet ergonomic laminated wood stock. A perfect precision tool for reaching your goals in hunting and competition.

Technical specifications

Models UPG und JPR

Model	Caliber					Barrel length				Muzzlethread			Trigger	Magazine	Safety	epoxy bedding	Length in cm	Weigth in kg
	308 Winchester (1:12 ^u)	6,5 Creedmoor (1:8 ^u)	6,5x47 Lapua (1:8 ^u)	243 Winchester (1:10 ^u)	450 Bushmaster (1:24 ^u)	16,5 ^u **	20 ^u	24 ^u	26 ^u	M15x1	5/8-24 UNEF	Picatinny Rail						
UPG-1	x	x	x	x	x	x	x	x	x		x	x					91-115	4,8-5,3
JPR-1 Europa	x	x	x	x	x	x	x	x	x	x						x	93-116	3-3,5
JPR-1 Monaco	x	x	x	x	x	x	x	x	x	x						x	93-116	2,8-3,3
JPR-1 Kodiak	x	x	x	x	x	x	x	x	x		x					x	93-116	3,6-4,1
JPR-1 Kodiak Scout	x				x	x					x	x				x	93	3,7
JPR-1 Nordland	x	x	x	x	x	x	x	x	x		x	x				x	91-115	4,2-4,7
JPR-1 Nordland Scout	x	x	x	x	x	x	x	x	x		x	x				x	91-115	4,2-4,7
JPR-1 Highland	x	x	x	x	x	x	x	x	x		x	x				x	93-117	3,8-4,3

two stage 0,9-2,5 kg

AICS standard

3 position Striker safety

* 16.5" barrel only available in .308 Winchester/450 Bushmaster



ProAction



The ideal Foundation

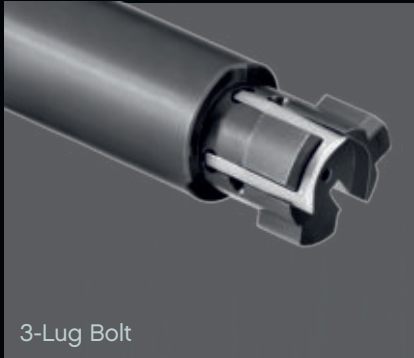

3-Lug Bolt

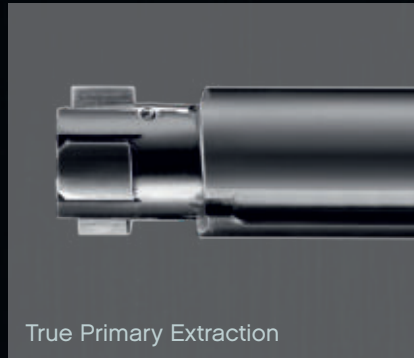

True Primary Extraction



Controlled Feeding

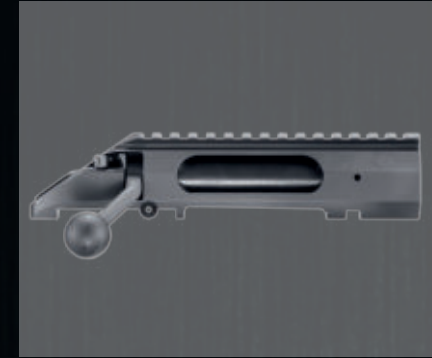

Controlled Ejection

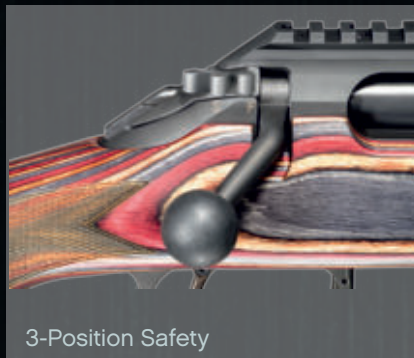

3-Position Safety



Compatible with
Mauser 98 Trigger
Packs



The ideal foundation for your next project. The only true primary extraction action on the market. Available in a number of action shapes.

ProAction Type 1

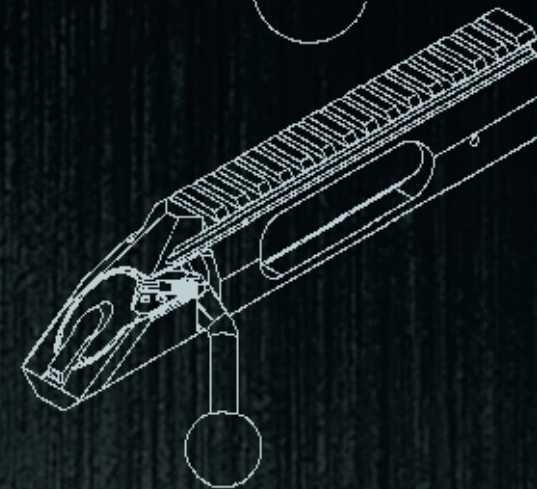
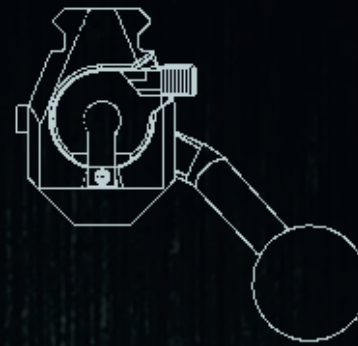
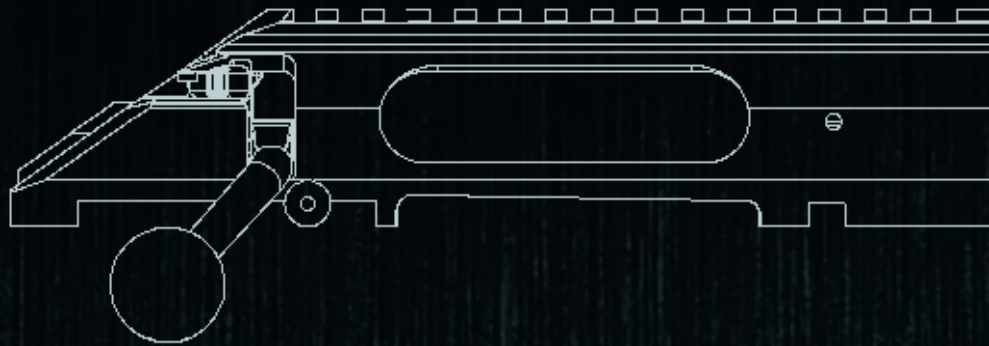

- Tac Action • Edged Design • Integrated M1913/STANAG 4694 Rail
- Cut for AICS short action magazines

ProAction Type 11

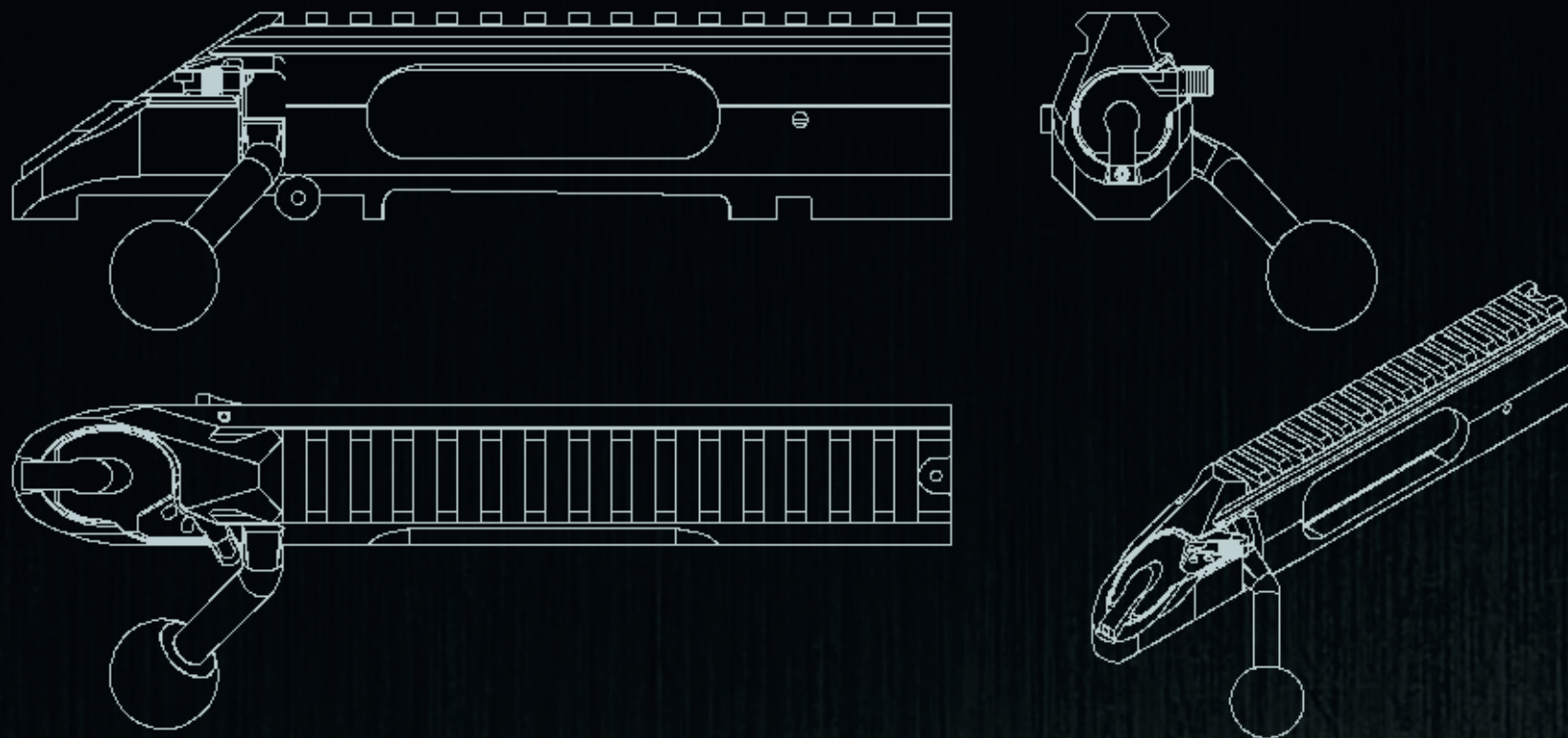

- Sport Action • Rounded Back Contour • Integrated M1913/STANAG 4694 Rail
- Drilled and Tapped for Rail Extension • Cut for AICS short action magazines

ProAction Type III

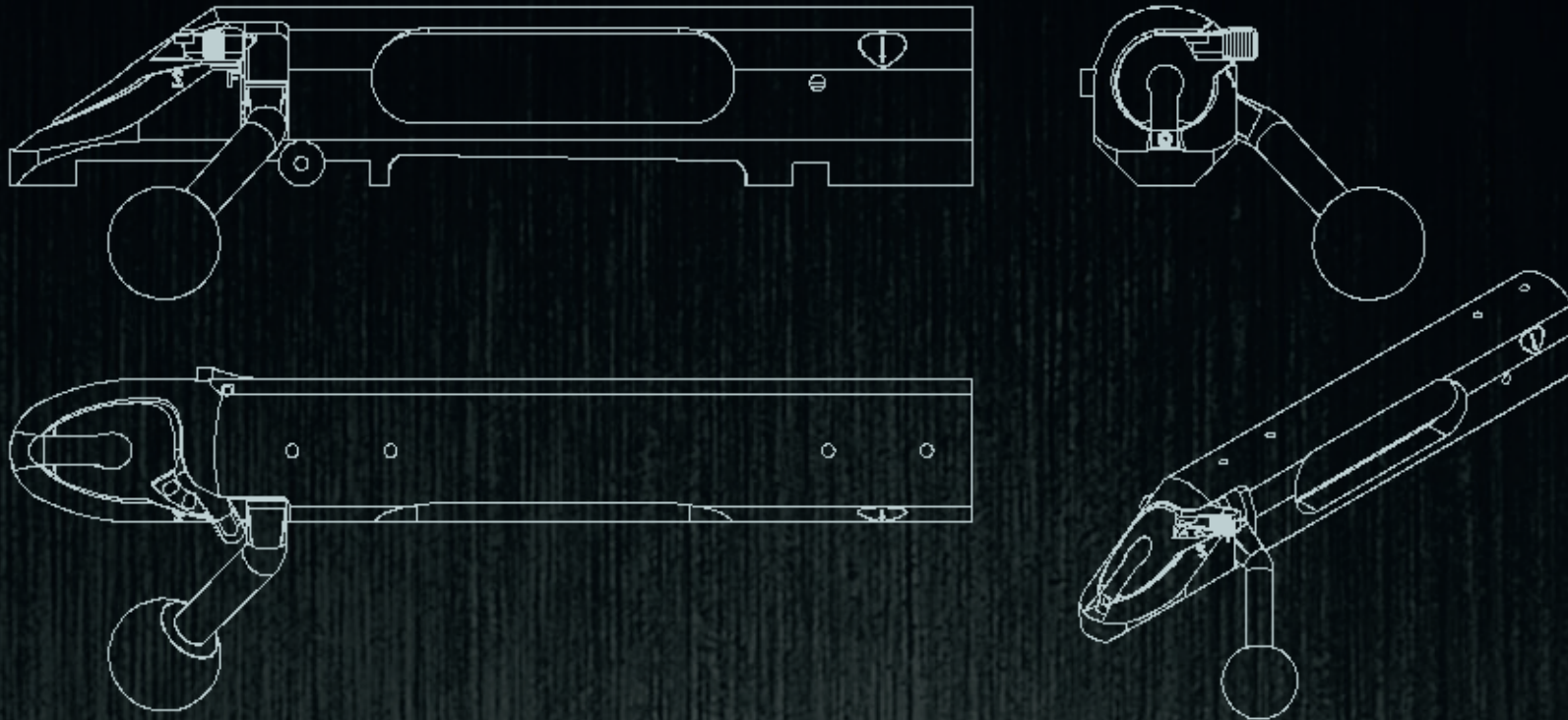

- Hunting Action • Top and Back Contour Rounded • Drilled and Tapped for Scope Use
- Cut for AICS short action magazines

ProAction Type IV

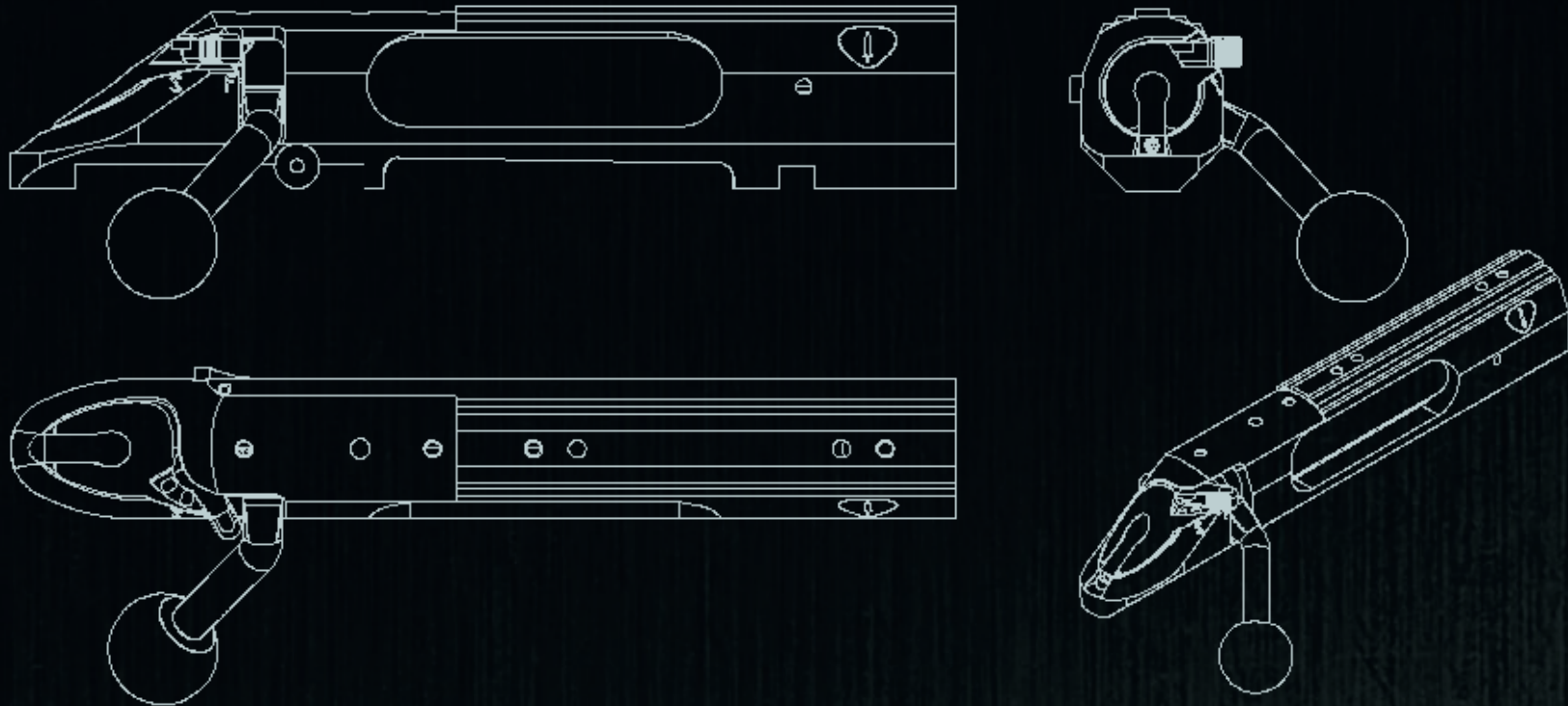

- Scout Action • Rounded Back Contour • Drilled and Tapped for Open Sights and Scope Rail
- Cut for AICS short action magazines

ProAction Type V

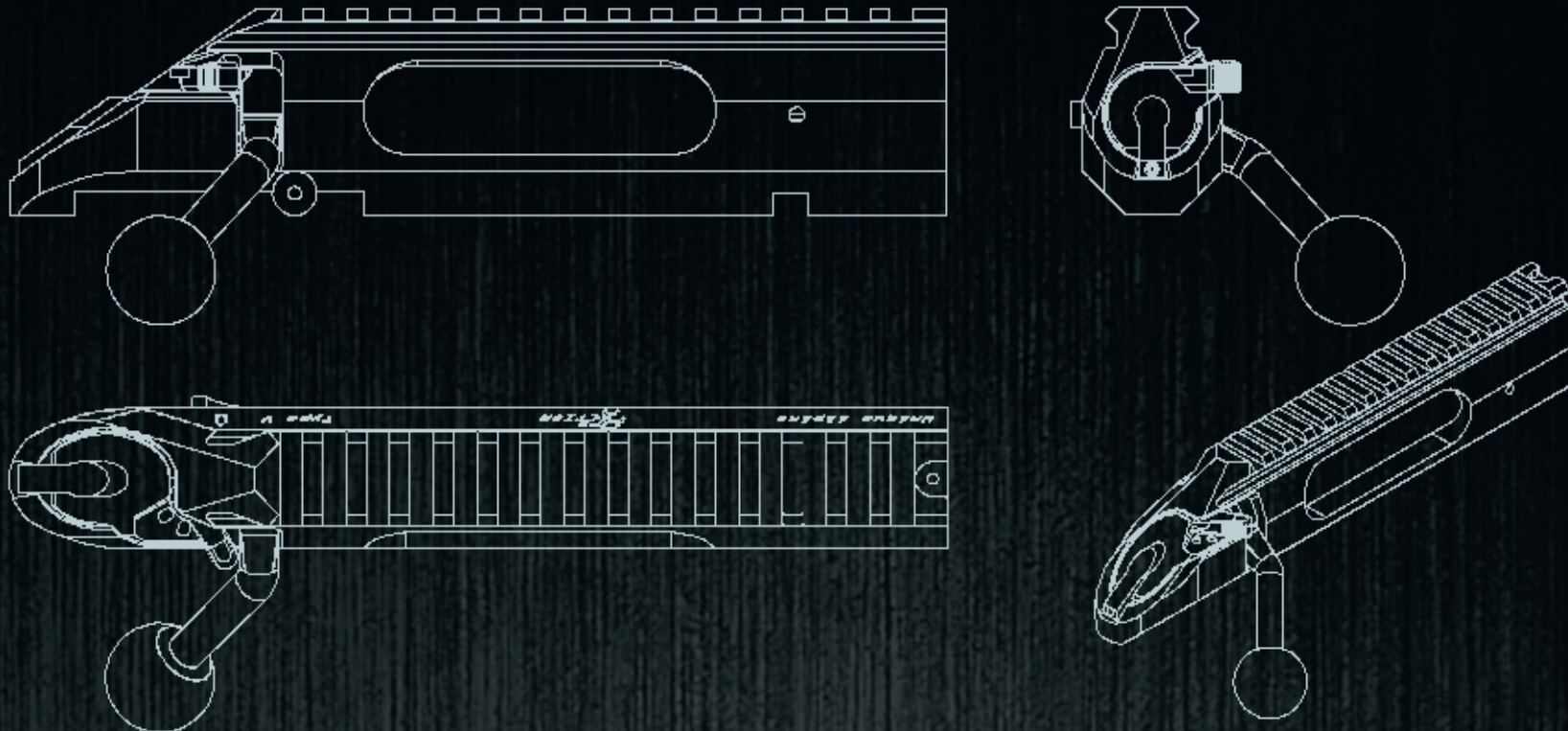

- Single Shot Action • For Benschrest/F-Flas Rifles • Rounded Back Contour
- Integrated M1913/STANAG 4694 Rail

Trigger UPG/JPR



Abzug UPG/JPR

- 2-Stage Match Grade Trigger • Adjustable Pre Travel • Sear Engagement • Pull Weight • Trigger Stop
- Pull Weight Range 0.9 - 2.5kg • Mauser-98-Style Interface (Mauser 98 actions may require modification)

ProAktion-Accessories



Trigger Guard



Bolt Handle



Trigger Shoe

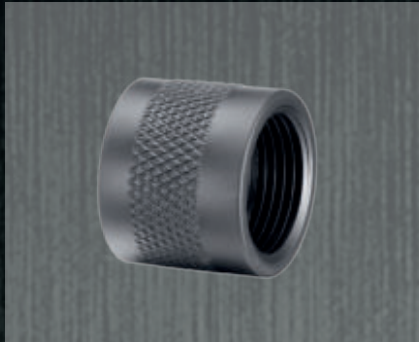

Muzzle Tread Protectors



Magazines



Muzzle Brakes

Modular Chassis System Rem700



- Modular Chassis System
- for Remington 700 Actions
- Easily Exchangeable Butt Stocks
- 2 Handguard Length Variants available
- AICS Magazine compatible



AICS Magazine



AICS Magazine 4 Round Capacity

AICS Compatible, Be aware of magazine well depth! Tikka T3(x) CTR, UPR compatible
Short Action Magazine 4 Round Capacity



AICS Magazine 10 Round Capacity

AICS Compatible, Be aware of magazine well depth! Tikka T3(x) Tac A1, CTR, UPR compatible
Short Action Magazine 10 Round Capacity



Optional High Visibility Magazine Insert

Accessories

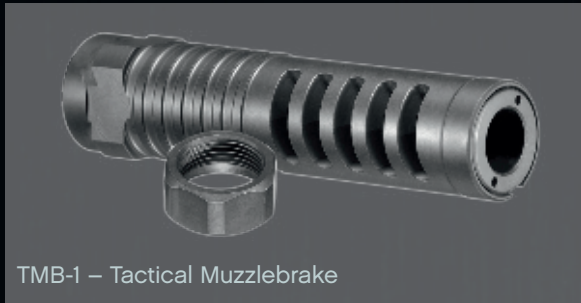

TMB-1 – Tactical Muzzlebrake

The UA Muzzlebrake is one of the most effective Muzzlebrakes on the market while still being quiet and slim. The shipment includes the required lock nut. Up to Caliber .366/9,3mm.

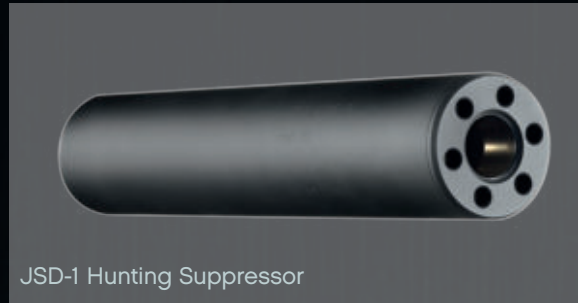

JSD-1 Hunting Suppressor

With our experience gained in Military and Law Enforcement projects we decided to develop a hunting suppressor. Due to the use of titanium parts the Unique Alpine JSD-1 is exceptionally rugged and durable while still being lightweight.

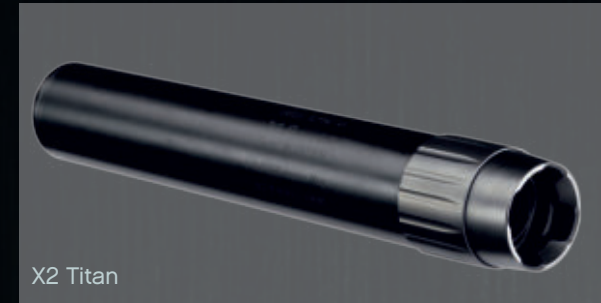

X2 Titan

Ready for business in seconds.

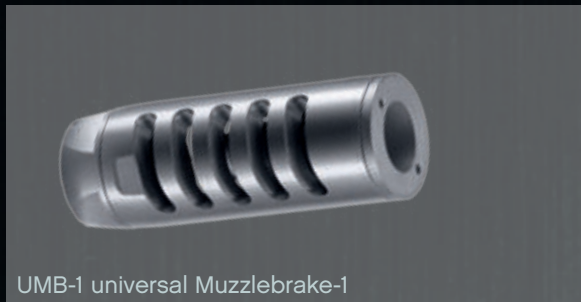

UMB-1 universal Muzzlebrake-1

Up to Caliber .307/7,62mm

- Highly Effective 10-Port Design with Gas Separator
- Secured by Shape Integrated Jam Nut
- Thread 5/8-24 UNEF
- Compact Design
- Ø25,5mm
- OAL ca.70mm
- Length Extending ca. 50mm
- Weight ca. 145g



JSD-2 und JSD-2-K

Light and durable like our JSD-1, the JSD-2 saves overall length by telescoping over the barrel.

JSD-2

- Over Barrel Suppressor
- Added Length: 140mm
- OAL: 255mm
- Ø 40mm

JSD-2-K

- Over Barrel Suppressor
- Added Length: 95mm
- OAL: 210mm
- Ø 40mm

- Weight ca. 680g
- Max. Barrel Ø21,5mm
- Stainless Steel/- Titanium
- Weight ca. 600g
- Max. Barrel Ø21,5mm
- Stainless Steel/- Titanium

Accessories



Advanced ergonomic pistolgrip

AR 15 compatible, Black, FDE (RAL 7008),Material: Glasfiber reinforced Polymer



Advanced ergonomic pistolgrip



Mirage strab

Length 320mm - 740mm, Width 50mm



M-Lok Rail Set

M1913/STANAG 4694 rail set with 60mm, 80mm and 100mm length. Material: Glasfiber reinforced Polymer

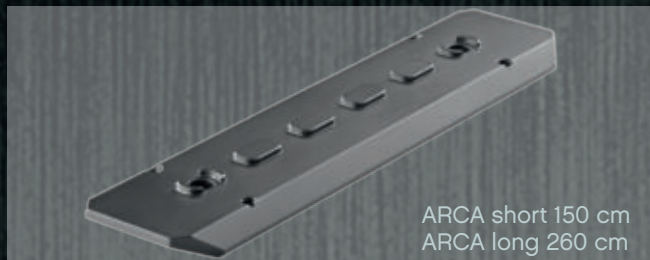

ARCA short 150 cm
ARCA long 260 cm



Gripextension

Stabalizing your stock with your supportiv Hand is way easier using the Buttstock Grip Extension. Furthermore the mountingpoint for monopods lowers by 50mm. Black, RAL 7008



M-Lok Harris Adapter

The Harris adapter enables you to mount a Harris bipod quickly, easily and inexpensively to your M-Lok Interface.



M-Lok QD sling mount

The M-Lok QD adapter enables you to mount standard QD-sling studs quickly, easily and inexpensively to your M-Lok Interface.



Target Arms



Hunting Arms



Adventure Arms



TPG-3 A4



UPG-1 Fixed Stock



UPG-1 AR-15 Foldable Buttstock



UPG-1 UA Foldable Buttstock



JPR-1 Nordland



JPR-1 Highland



JPR-1 Nordland Scout



JPR-1 Europa



JPR-1 Monaco



JPR-1 Highland



JPR-1 Kodiak



JPR-1 Nordland



JPR-1 Nordland Scout



JPR-1 Kodiak Scout



JPR-1 Nordland Scout



JPR-1 Kodiak Scout



Target

Tools delivering surgical precision to your hands, ensuring you every possibility for success in your shooting.



Hunting

Your reliable partner for the great outdoors, giving you absolute confidence on your ethical hunt.



Adventure

Unrivalled rifles, Ideal for every outdoor experience from a local hike or a trip in the Canadian Wilderness.



Perfection in your hands

Unique Alpine AG • Rennweg 33 • 85435 Erding • Tel: +49 8122 999 814-0 • Fax: +49 8122 999 814-950 • www.unique-alpine.com